

# LEDON®

No. 642050 - Bird

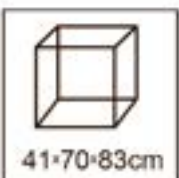

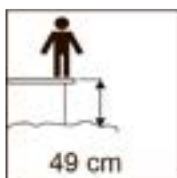

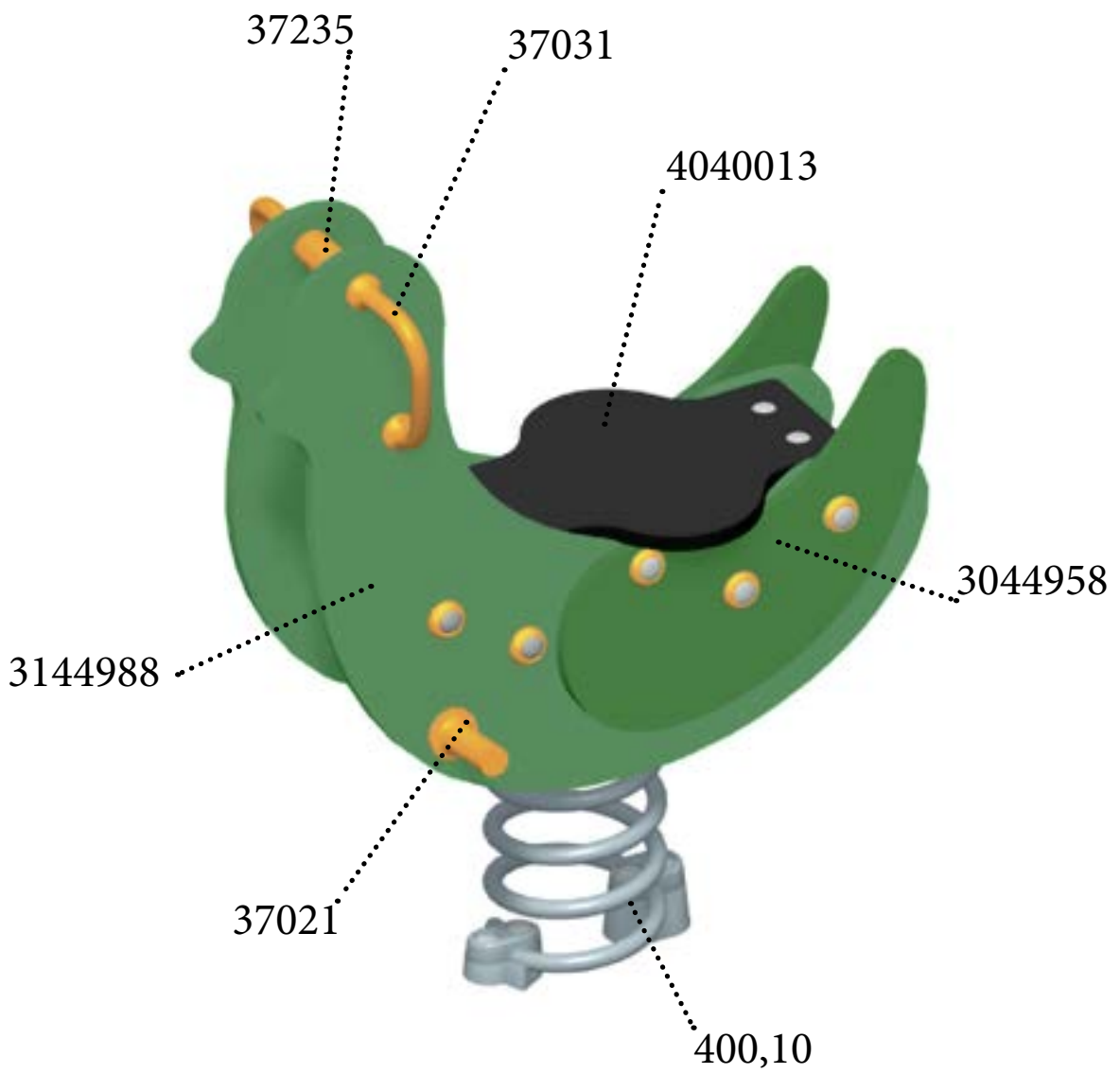

4 Pcs.		10x25 MB
4 Pcs.		LM 10
2 Pcs.		GTL
2 Pcs.		GTF
1 Pcs.		
2 Pcs.		LM 6
2 Pcs.		M6x16 Pin TX30
1 Pcs.		TK 30
2 Pcs.		

Fig. 1

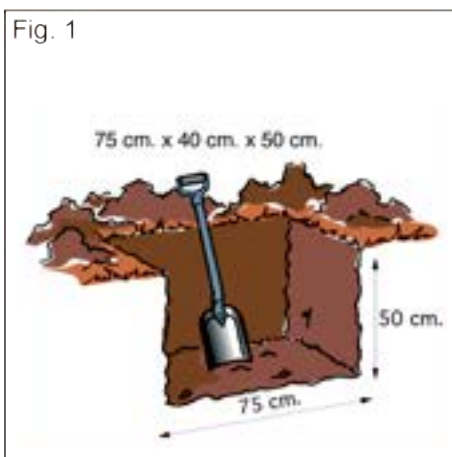

Fig. 2

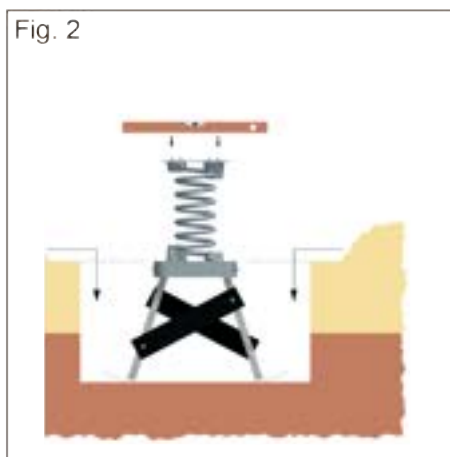

Fig. 3

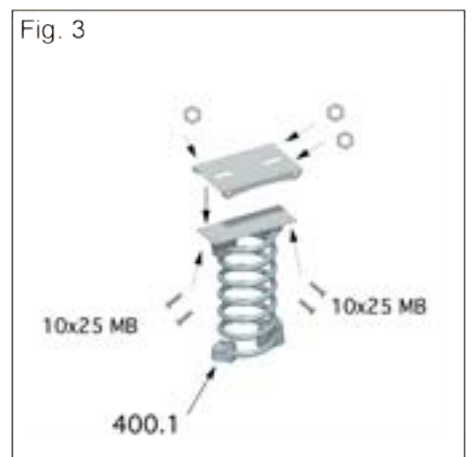

Fig. 4

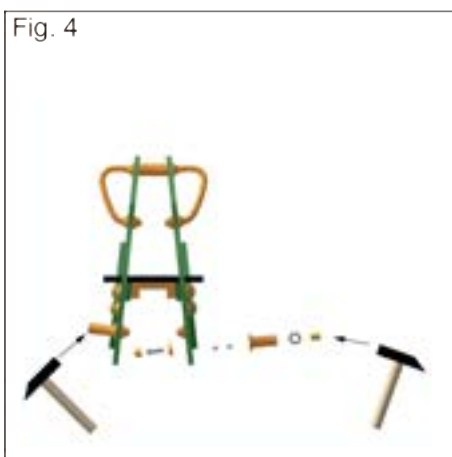

Fig. 5

