

# LEDON®

No. 413 - Tapir

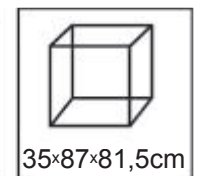

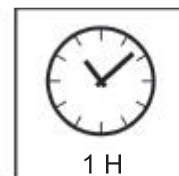

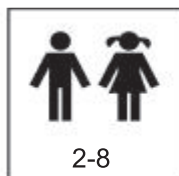
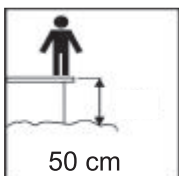
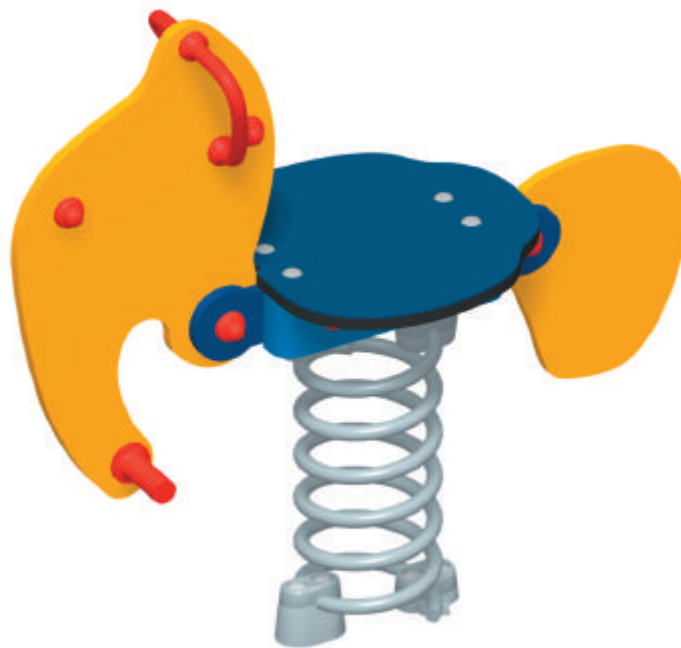
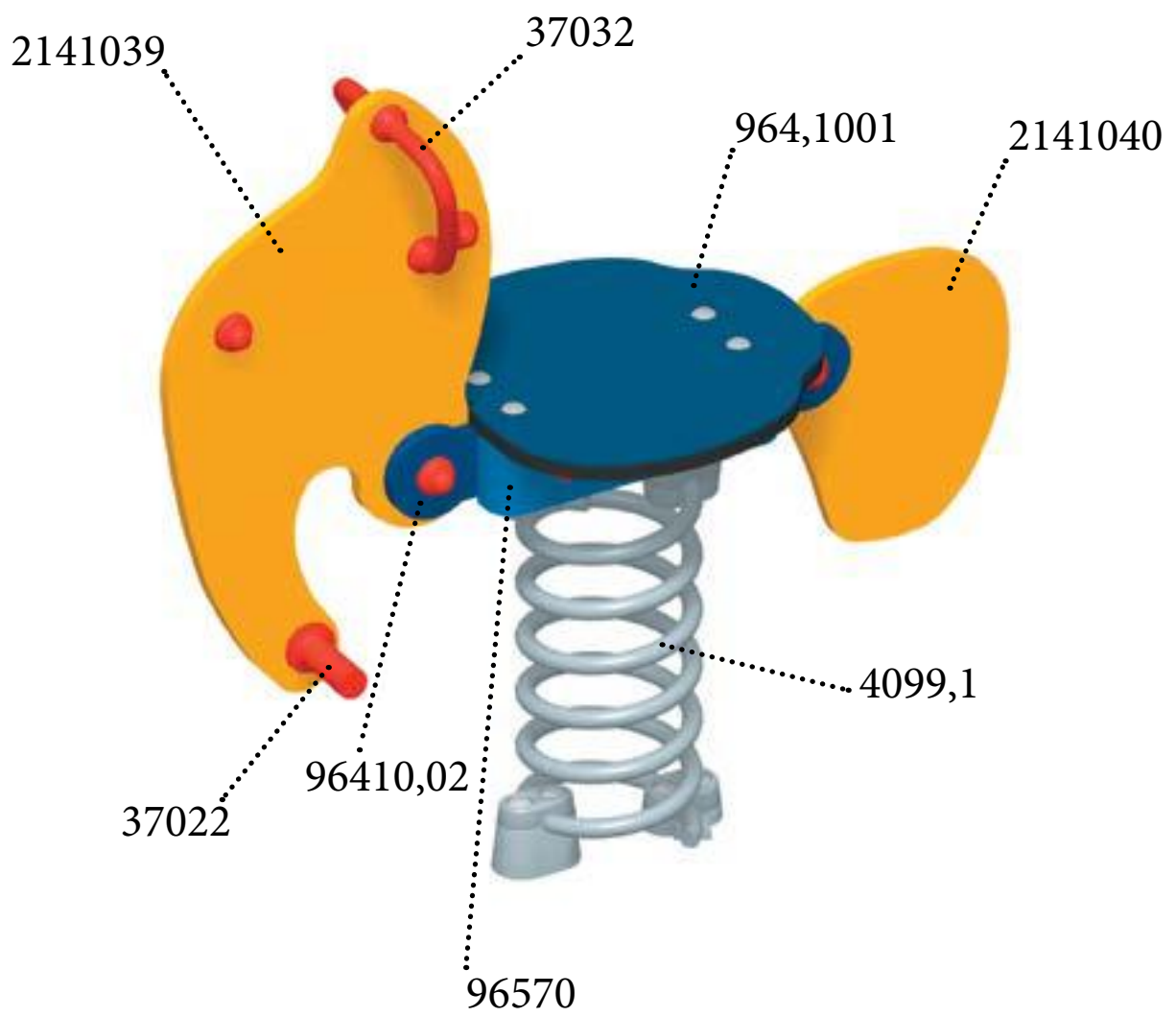

Faldunderlag: I overensstemmelse med EN 1177

Safety surface: In accordance with EN 1177

Fallschutzbelag: Gemäß EN 1177







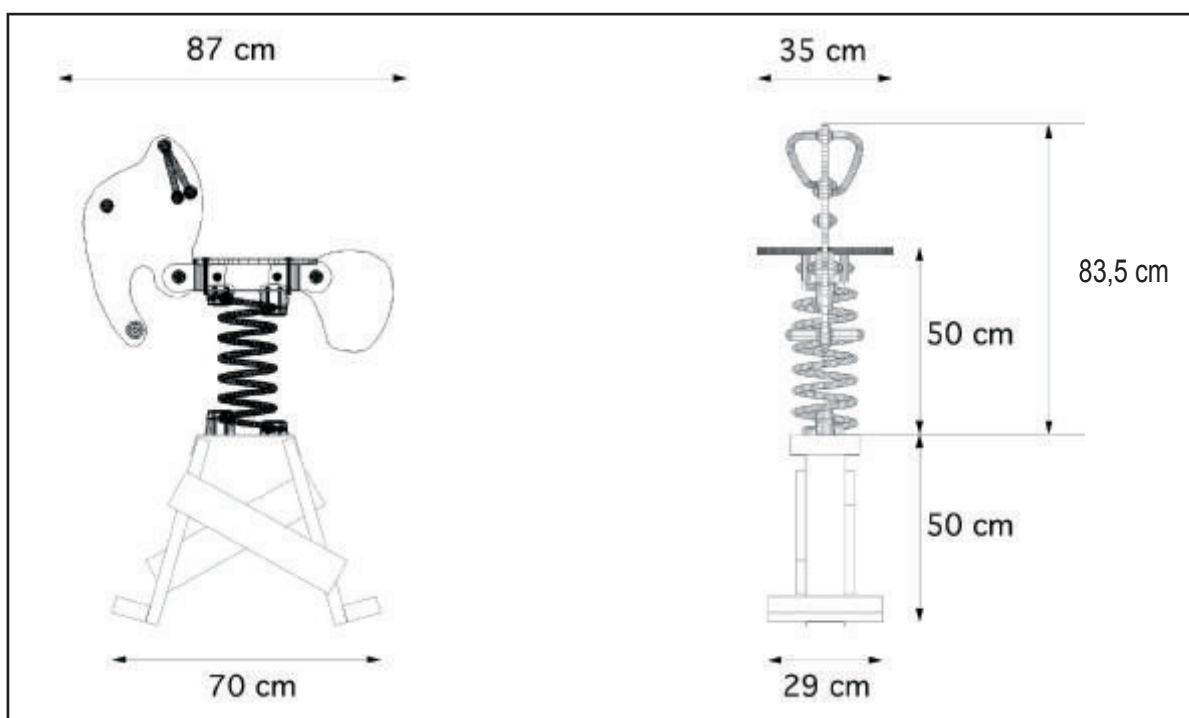
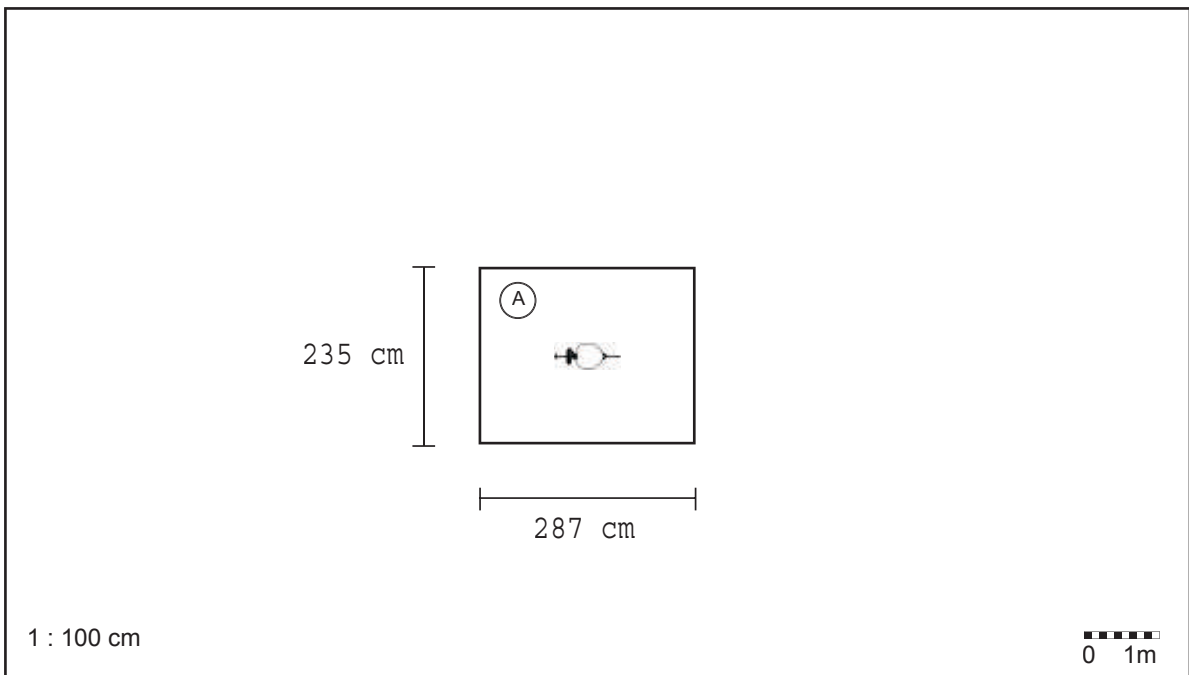

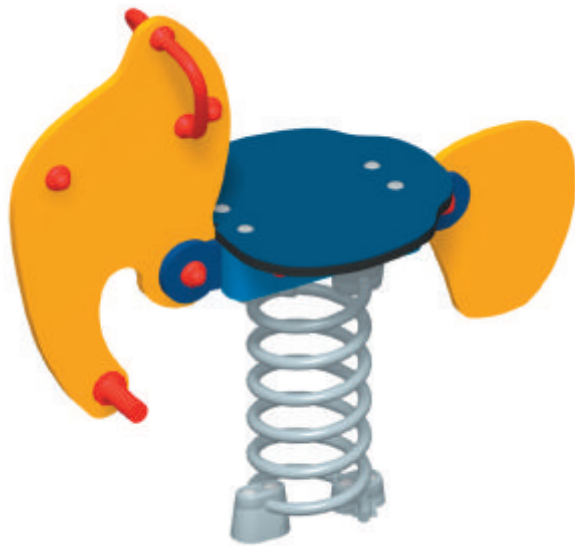

Zone D'impact d'après norme EN 1177

Fundamento de caída según norma EN 1177

		
(A)	50 cm	6,75 m2





2 Pcs.		10x70 MB
2 Pcs.		10x120 MB
4 Pcs.		10x100 BB A2
8 Pcs.		LM 10
4 Pcs.		RSL
8 Pcs.		RTL
4 Pcs.		GT
2 Pcs.		LM 6
2 Pcs.		M6x16 Pin TX 30
1 Pcs.		TK 30
2 Pcs.	