

PARTS LIST

ITEM	QTY	PART NUMBER	DESCRIPTION	STOCK NUMBER
1	3	TB-200-733_B	750MM X 125MM (POST INSERT)	COMTIMSAF0001
2	2	TB-200-734_B	850MM X 125MM (POST INSERT)	COMTIMSAF0001
3	3	TB-200-735_B	950MM X 125MM (POST INSERT)	COMTIMSAF0001
4	8	MOD-600-121 GROUND FOOT (125)	GROUND FOOT (125)	SUBSTEMIS0006
5	8	300 x 300 x 400	0.036M <sup>3</sup> CONCRETE FOUNDATION	

INDICATOR SIGN

ITEM	QTY	PART NUMBER	DESCRIPTION
1	1	TB-200-399_B	1100 x 112mm (FC281650P)
2	1	PE-400-035	INDICATOR SIGN
3	1	MOD-600-116 GROUND FOOT (112)	GROUND FOOT (112)
4	4	M3 X 25 POZI PAN SCREW	25MM POZI PAN SCREW
5	1	300 x 300 x 400	0.036M <sup>3</sup> CONCRETE FOUNDATION

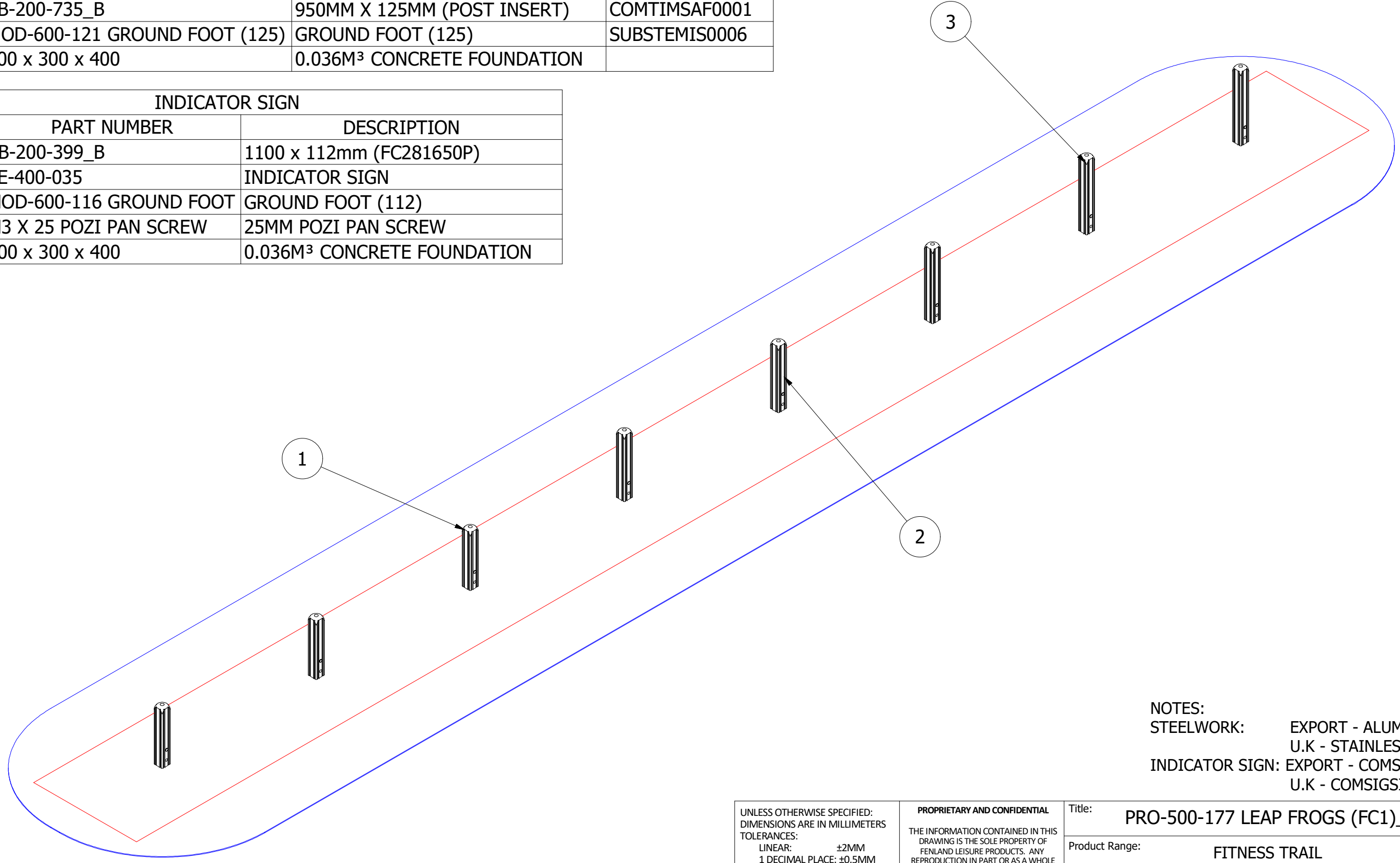

NOTES:  
 STEELWORK: EXPORT - ALUMINIUM  
 U.K - STAINLESS STEEL  
 INDICATOR SIGN: EXPORT - COMSIGSIG0042  
 U.K - COMSIGSIG0032

UNLESS OTHERWISE SPECIFIED: DIMENSIONS ARE IN MILLIMETERS TOLERANCES: LINEAR: ±2MM 1 DECIMAL PLACE: ±0.5MM ANGULAR: ±1°	<b>PROPRIETARY AND CONFIDENTIAL</b> THE INFORMATION CONTAINED IN THIS DRAWING IS THE SOLE PROPERTY OF FENLAND LEISURE PRODUCTS. ANY REPRODUCTION IN PART OR AS A WHOLE WITHOUT THE WRITTEN PERMISSION OF FENLAND LEISURE PRODUCTS IS PROHIBITED.	Title: PRO-500-177 LEAP FROGS (FC1)_SF	
		Product Range: FITNESS TRAIL	
		1.0M FFH	Date: 05/07/2021
		DO NOT SCALE FROM DRAWING	
		Page: A3	
Tel: 01354 638359 www.onlineplaygrounds.co.uk			

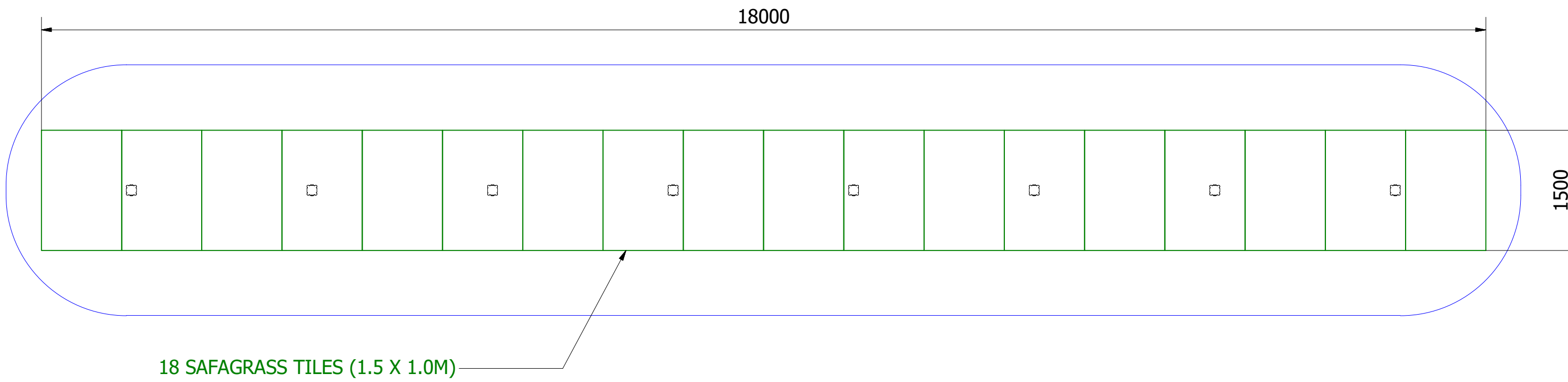
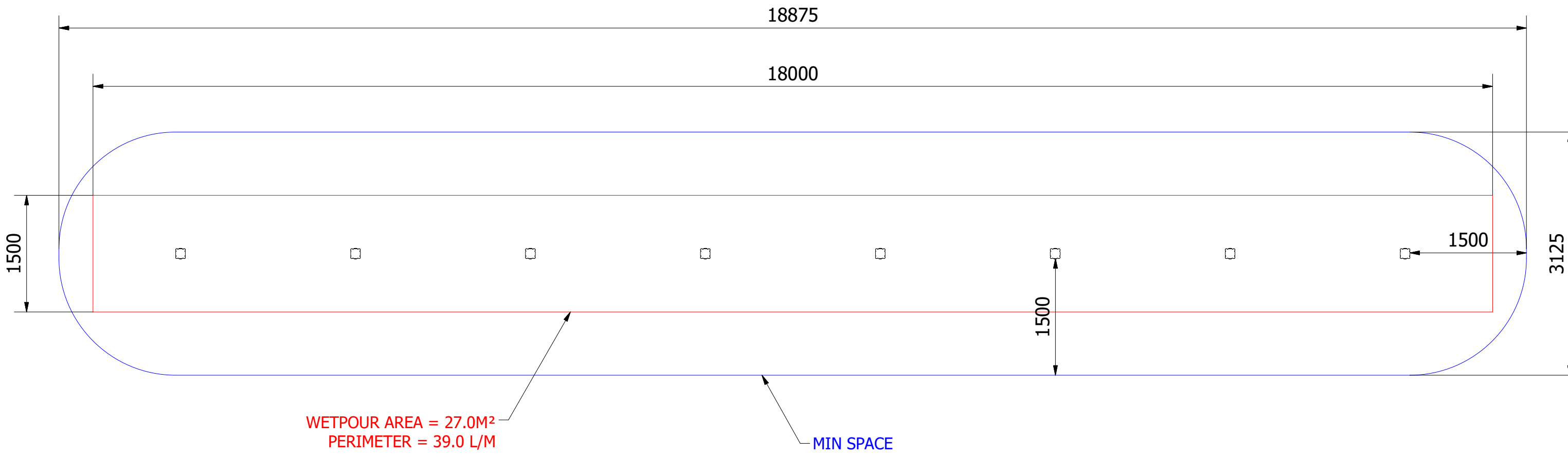

UNLESS OTHERWISE SPECIFIED: DIMENSIONS ARE IN MILLIMETERS TOLERANCES: LINEAR: ±2MM 1 DECIMAL PLACE: ±0.5MM ANGULAR: ±1°	<b>PROPRIETARY AND CONFIDENTIAL</b> THE INFORMATION CONTAINED IN THIS DRAWING IS THE SOLE PROPERTY OF FENLAND LEISURE PRODUCTS. ANY REPRODUCTION IN PART OR AS A WHOLE WITHOUT THE WRITTEN PERMISSION OF FENLAND LEISURE PRODUCTS IS PROHIBITED.	Title: <b>PRO-500-177 LEAP FROGS (FC1)_SF</b>	
		Product Range: <b>FITNESS TRAIL</b>	
		Date: 05/07/2021	
		Page: A3	
		DO NOT SCALE FROM DRAWING	
Tel: 01354 638359 www.onlineplaygrounds.co.uk			

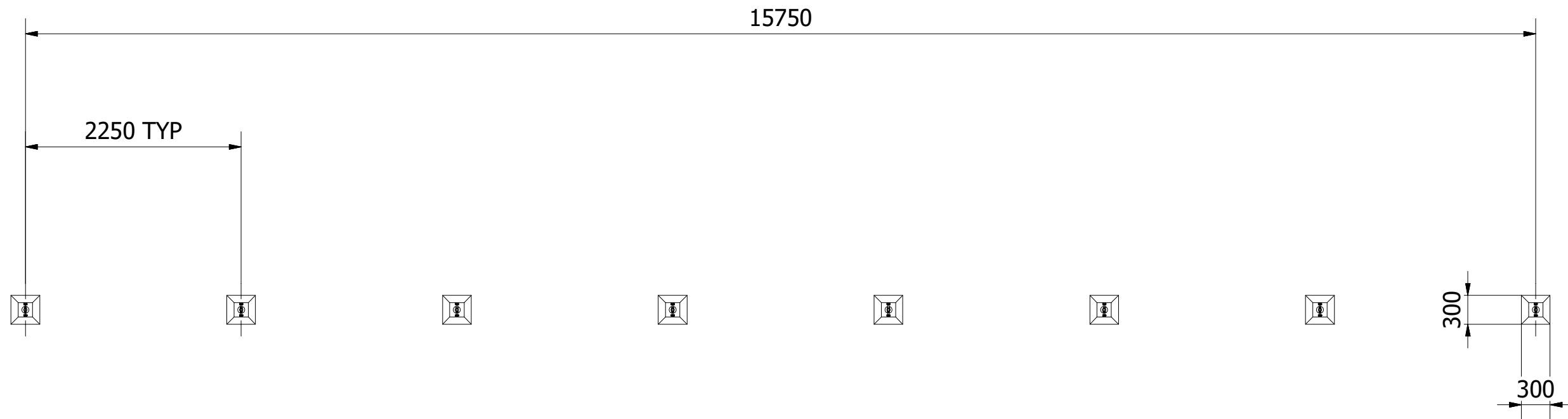

ALL FOUNDATIONS 300 X 300 X 500 DEEP UNLESS OTHERWISE SPECIFIED

UNLESS OTHERWISE SPECIFIED: DIMENSIONS ARE IN MILLIMETERS TOLERANCES: LINEAR: ±2MM 1 DECIMAL PLACE: ±0.5MM ANGULAR: ±1°	<b>PROPRIETARY AND CONFIDENTIAL</b> THE INFORMATION CONTAINED IN THIS DRAWING IS THE SOLE PROPERTY OF FENLAND LEISURE PRODUCTS. ANY REPRODUCTION IN PART OR AS A WHOLE WITHOUT THE WRITTEN PERMISSION OF FENLAND LEISURE PRODUCTS IS PROHIBITED.	Title: <b>PRO-500-177 LEAP FROGS (FC1)_SF</b>	
		Product Range: <b>FITNESS TRAIL</b>	
		Date: 05/07/2021	
		Page: A3	
		DO NOT SCALE FROM DRAWING	
		Tel: 01354 638359 www.onlineplaygrounds.co.uk	

1. POSITION EACH OF THE UPRIGHT POSTS INTO THE FOUNDATION HOLES. ENSURE ALL POSTS ARE LEVEL AND PLUMB BEFORE ADDING CONCRETE TO THE FOUNDATION HOLES AND LEAVE FOR 48 HOURS

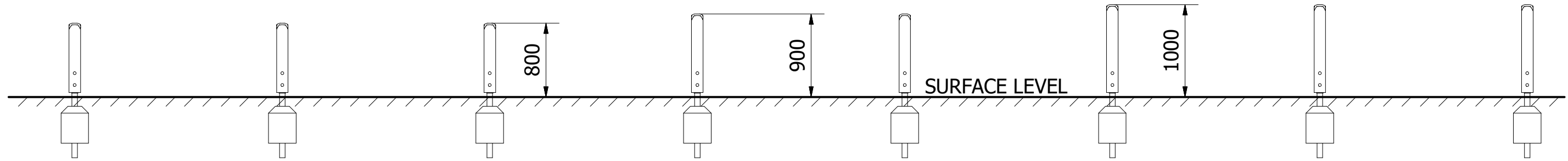

**FOUNDATION DETAIL**

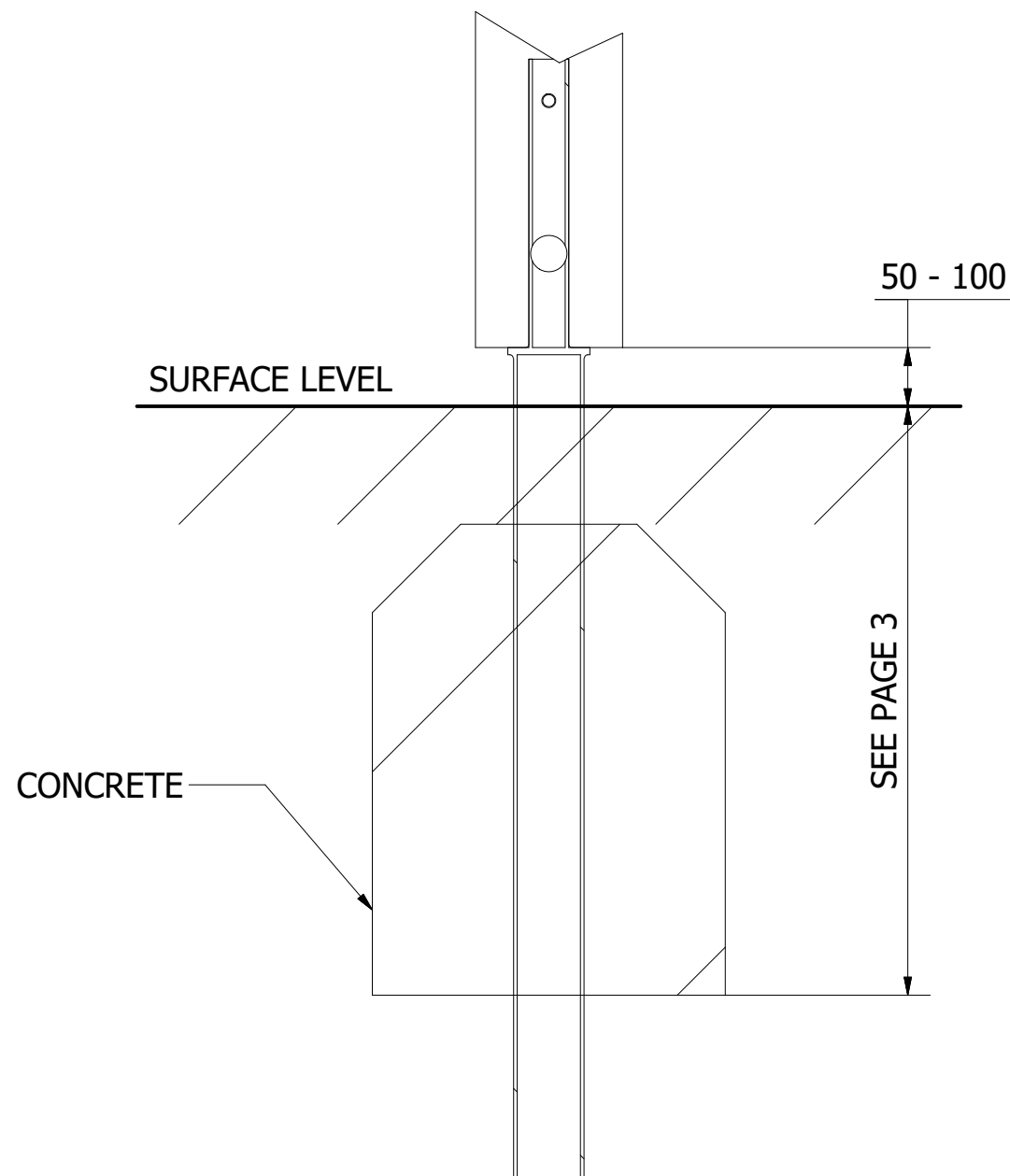

UNLESS OTHERWISE SPECIFIED:  
DIMENSIONS ARE IN MILLIMETERS  
TOLERANCES:  
LINEAR: ±2MM  
1 DECIMAL PLACE: ±0.5MM  
ANGULAR: ±1°

**PROPRIETARY AND CONFIDENTIAL**  
THE INFORMATION CONTAINED IN THIS  
DRAWING IS THE SOLE PROPERTY OF  
FENLAND LEISURE PRODUCTS. ANY  
REPRODUCTION IN PART OR AS A WHOLE  
WITHOUT THE WRITTEN PERMISSION  
OF FENLAND  
LEISURE PRODUCTS IS PROHIBITED.

Title: **PRO-500-177 LEAP FROGS (FC1)\_SF**

Product Range: **FITNESS TRAIL**

Date:  
05/07/2021

Page:  
A3



DO NOT SCALE FROM DRAWING

Tel: 01354 638359 www.onlineplaygrounds.co.uk